

Features

- For baths 21" (533 mm) to 26" (660 mm) deep from the center of the bath overflow outlet to the center of the bath drain outlet.
- 45" (1143 mm) length external cable.
- Includes drain ell, overflow ell and overflow tube.
- Flexible overflow joint conforms to various bath angles.
- No internal linkages to minimize the potential for clogging.
- Less horizontal PVC tube and tee.
- For use with any PureFlo rotary or push hand controls and pop-up drain stopper kit (sold separately).

Material

- Schedule 40 PVC construction.

Installation

- Can be installed and tested without required trim kit.
- Above- or through-floor installation.
- Flexible overflow joint conforms to various bath angles for easy installation.

Required Products/Accessories

K-T37391 Rotary-turn bath drain trim

or

K-T37392 Rotary-turn bath drain trim

or

K-T37393 Rotary-turn bath drain trim

or

K-T37394 Rotary-turn bath drain trim

or

K-T37395 Bath drain trim

or

K-T37396 Push-button bath drain trim

or

K-T37397 Push-button bath drain trim

Recommended Products/Accessories

K-23726 Drain treatment

K-23723 Faucet cleaner



Codes/Standards

ASME A112.18.2/CSA B125.2

KOHLER® One-Year Limited Warranty

See website for detailed warranty information.

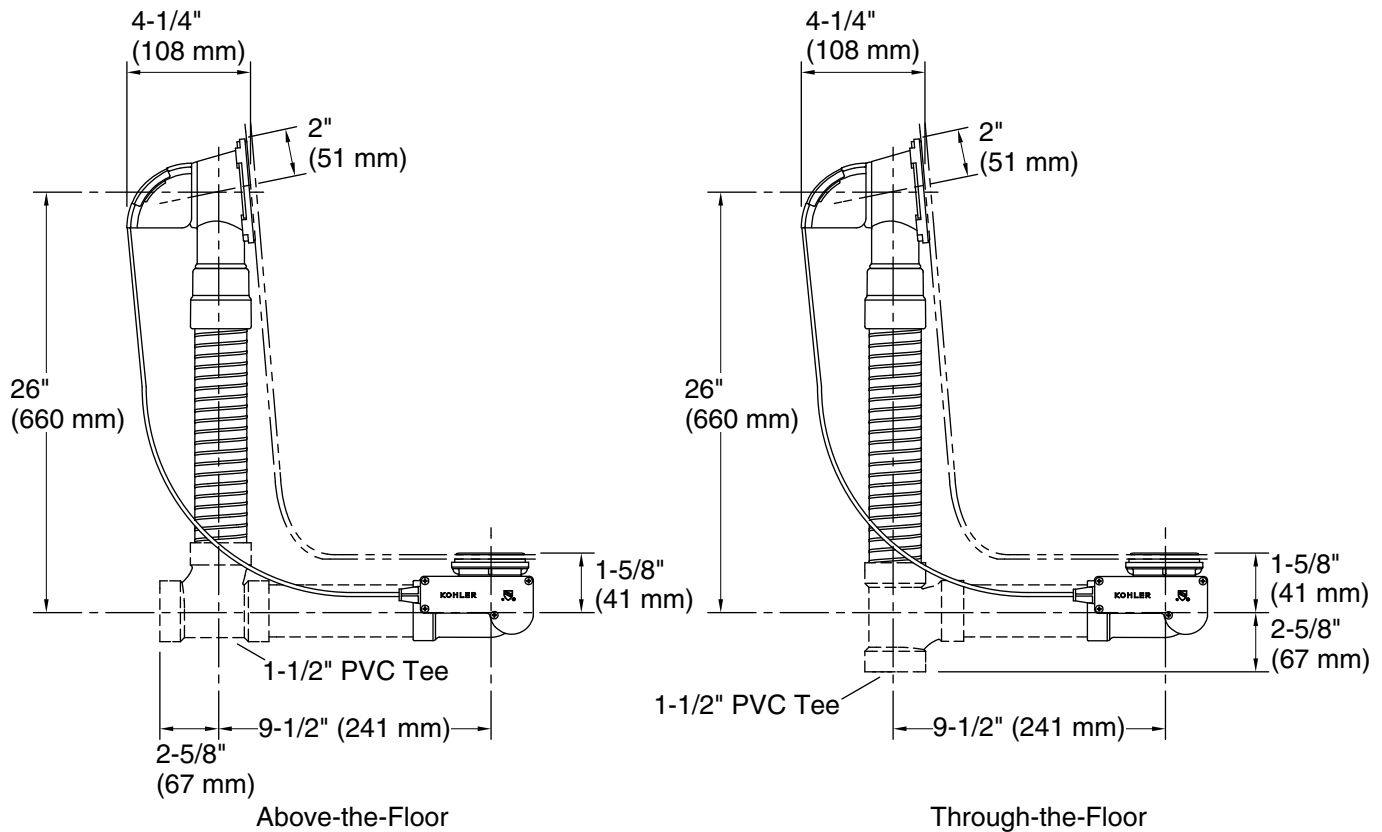

Technical Information

All product dimensions are nominal.

Drain included: Yes

Notes

Install this product according to the installation guide.

The combined length of the vertical tubing (supplied) and horizontal tubing (not supplied) after being cut for the bath installation must be equal to or less than 40" (1016 mm) for 45" (1143 mm) cable bath drain.